

3 - CHANNEL LIGHT ORGAN

3-channel light organ (Low, Mid and High) in an attractive translucent enclosure to create your own lightshows.

Total solder points: 110

Difficulty level: *beginner* 1 2 3 4 5 *advanced*



K8017

Features:

- ☑ Low, Mid and High channels
- ☑ Sensitivity adjustment per channel
- ☑ LED indication per channel
- ☑ Attractive translucent enclosure
- ☑ Microphone included
- ☑ Noise suppressed according to EN55015

Specifications:

- Operating voltages : 110-125 or 220-240VAC 50/60Hz
- Max. load : 200W per channel (100W @ 110-125VAC)
- Only suited for incandescent light bulbs
- Dimensions (WxHxD) 155x45x160mm (6.2"x1.8"x6.4")

modifications reserved



1. Assembly (Skipping this can lead to troubles !)

Ok, so we have your attention. These hints will help you to make this project successful. Read them carefully.

1.1 Make sure you have the right tools:

- A good quality soldering iron (25-40W) with a small tip.
- Wipe it often on a wet sponge or cloth, to keep it clean; then apply solder to the tip, to give it a wet look. This is called 'thinning' and will protect the tip, and enables you to make good connections. When solder rolls off the tip, it needs cleaning.
- Thin raisin-core solder. Do not use any flux or grease.
- A diagonal cutter to trim excess wires. To avoid injury when cutting excess hold the lead so they cannot fly towards the eyes.
- Needle nose pliers, for bending leads, or to hold components in place.
- Small blade and Phillips screwdrivers. A basic range is fine.

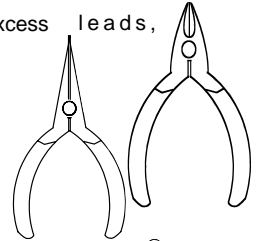
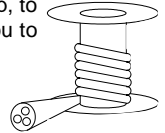
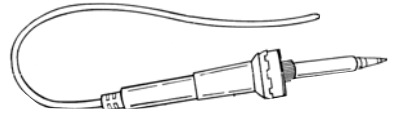

leads,



For some projects, a basic multi-meter is required, or might be handy

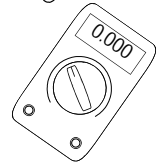

1.2 Assembly Hints :

- ⇒ Make sure the skill level matches your experience, to avoid disappointments.
 - ⇒ Follow the instructions carefully. Read and understand the entire step before you perform each operation.
 - ⇒ Perform the assembly in the correct order as stated in this manual
 - ⇒ Position all parts on the PCB (Printed Circuit Board) as shown on the drawings.
 - ⇒ Values on the circuit diagram are subject to changes.
 - ⇒ Values in this assembly guide are correct*
 - ⇒ Use the check-boxes to mark your progress.
 - ⇒ Please read the included information on safety and customer service
- ⇒ * Typographical inaccuracies excluded. Always look for possible last minute manual updates, indicated as 'NOTE' on a separate leaflet.

1.3 Soldering Hints :

1- Mount the component against the PCB surface and carefully solder the leads

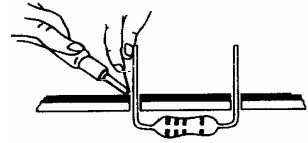

2- Make sure the solder joints are cone-shaped and shiny

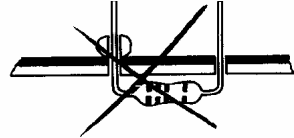
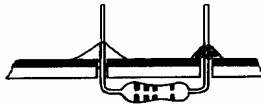

3- Trim excess leads as close as possible to the solder joint

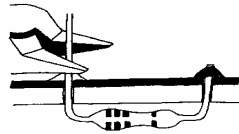

REMOVE THEM FROM THE TAPE ONE AT A TIME !

AXIAL COMPONENTS ARE TAPED IN THE CORRECT MOUNTING SEQUENCE !

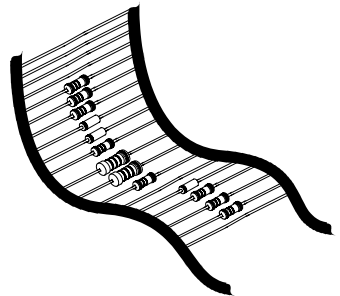

1. Diode. Watch the polarity!

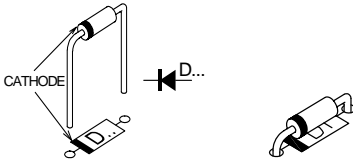

- D1 : 1N4007

2. Zener diode. Watch the polarity!

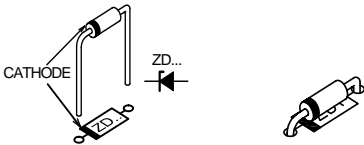

- ZD1 : 12V0 / 1,3W

3. 1/4W Resistors

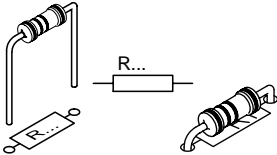

- R1 : 4K7 (4 - 7 - 2 - B)
- R2 : 100K (1 - 0 - 4 - B)
- R3 : 4M7 (4 - 7 - 5 - B)
- R4 : 22K (2 - 2 - 3 - B)
- R5 : 470K (4 - 7 - 4 - B)
- R6 : 1K5 (1 - 5 - 2 - B)
- R7 : 4K7 (4 - 7 - 2 - B)
- R8 : 4E7 (4 - 7 - B - B)
- R9 : 4E7 (4 - 7 - B - B)
- R10 : 4E7 (4 - 7 - B - B)
- R11 : 470K (4 - 7 - 4 - B)
- R12 : 470K (4 - 7 - 4 - B)

4. Metal film resistors

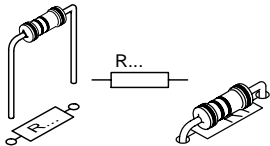

- R13 : 10K (1 - 0 - 3 - B - 9)
- R14 : 10K (1 - 0 - 3 - B - 9)
- R15 : 10K (1 - 0 - 3 - B - 9)
- R16 : 10K (1 - 0 - 3 - B - 9)
- R17 : 10K (1 - 0 - 3 - B - 9)
- R18 : 10K (1 - 0 - 3 - B - 9)

5. Ceramic Capacitors

- C1 : 100nF (104 - μ 1)
 - C2 : 100nF (104 - μ 1)
 - C3 : 1 μ F (105)
 - C4 : 100nF (104 - μ 1)
 - C5 : 47nF (473)
-

6. Transistors

- T1 : BC547B
 - T2 : BC547B
-

7. PCB tabs

- SK1 (2X)
 - SK2 (2X)
 - SK3 (2X)
 - SK4 (2X)
-

- MIC1 -
- MIC1 +

8. LEDs. Watch the polarity!

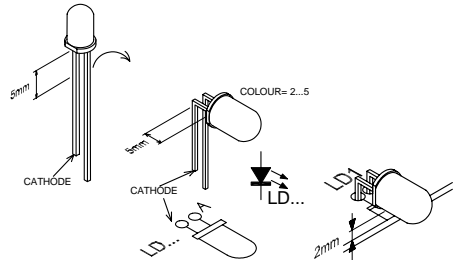

- LD1: 5mm LED RED

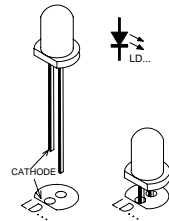

- LD2: 5mm LED GREEN
- LD3: 5mm LED YELLOW
- LD4: 5mm LED RED

9. Microphone

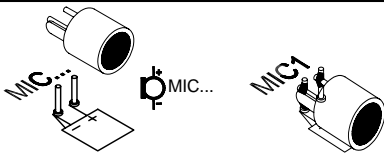

- MIC1

10. Capacitors

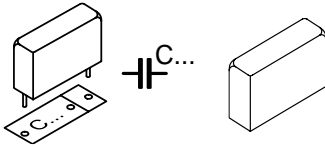

Choose operating voltage :

For 110 - 125VAC :

- C7 : 220nF / 250VAC
- C8 : 470nF / 250VAC

For 220 - 240VAC :

- C7 : 470nF / 250VAC
- C8 : 220nF / 250VAC

11. Electrolytic capacitor. Check the polarity!

- C6 : 470µF / 16V

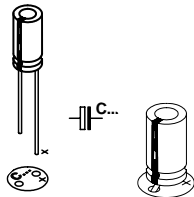

12. Fuse holder + fuse

- F1 : 3,15A T (slow)

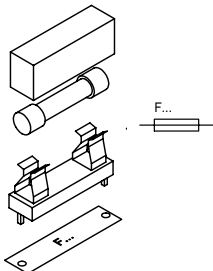

13. Thyristors

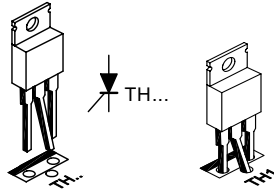

- TH1 : TIC 106M or eq.
- TH2 : TIC 106M or eq.
- TH3 : TIC 106M or eq.

14. Choke

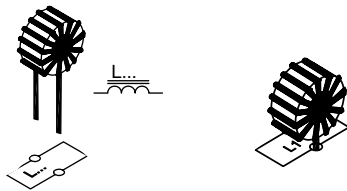

- L1

15. Resistor trimmers

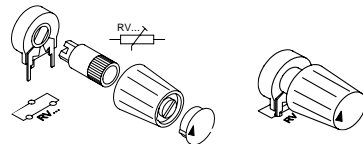

- RV1 : 10K
- RV2 : 10K
- RV3 : 10K
- RV4 : 10K

16. Assembly

- ❑ Mount the snap-in AC sockets on their support.

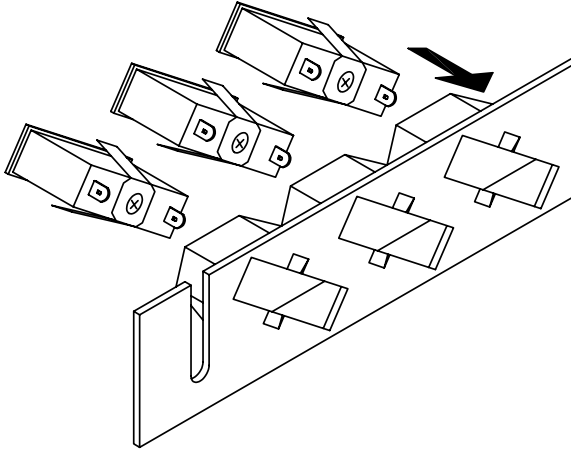

- ❑ Mount the PCB on the bottom lid of the enclosure and fasten with the supplied screws. (Use the shortest supplied screws)

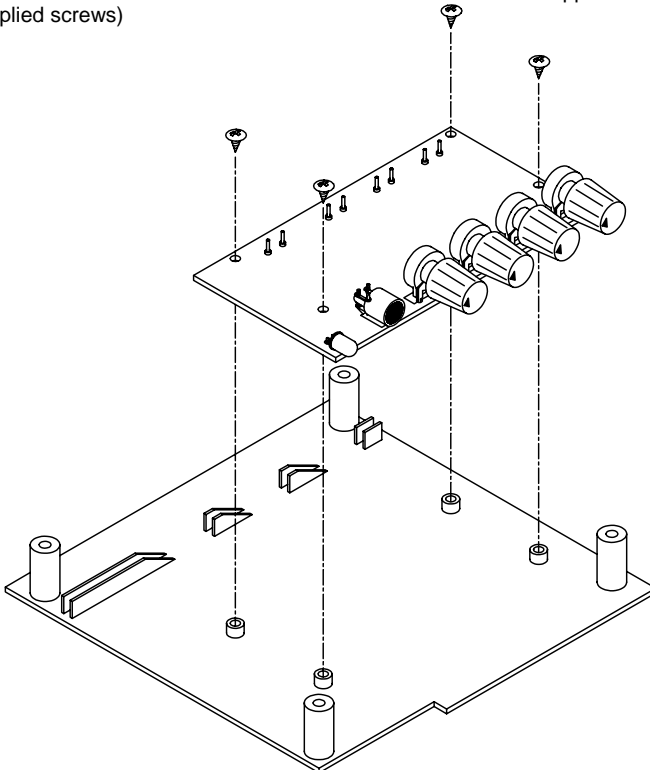

- Position the socket support on the bottom lid.

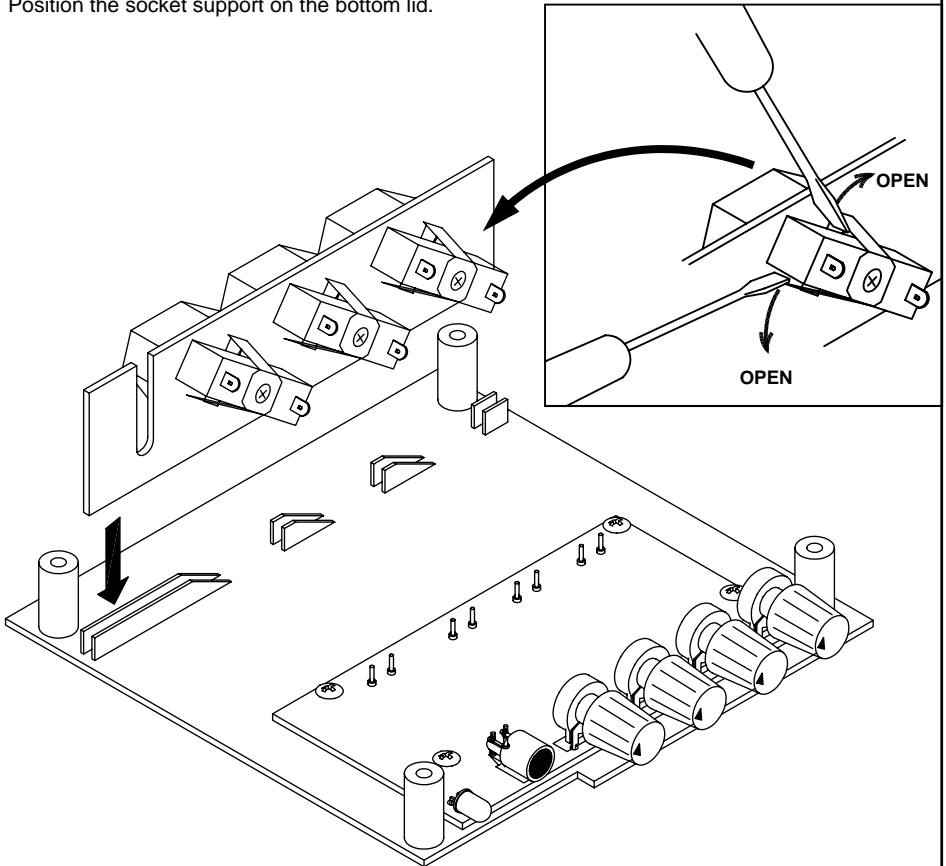

- Run about 10 cm (4") of the supplied wire trough the hole in the enclosure lid. Click the strain relief on the cable, and squeeze it into the hole, until it fits snugly

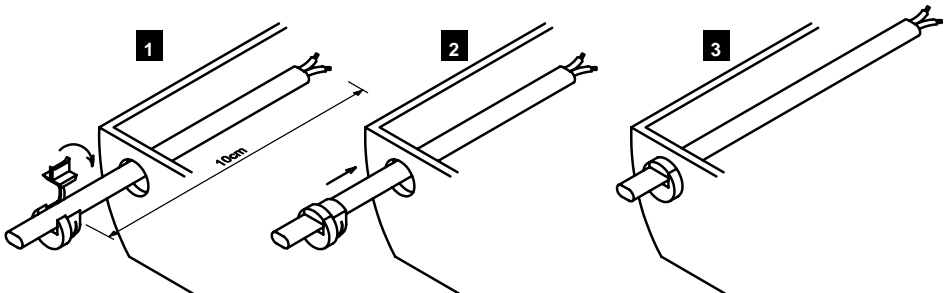

- ❑ Solder the AC cable to the SK1 pins. Connect the AC sockets to the board with the supplied wire. Inspect the whole assembly once more before closing the lid. Fasten the lid with the supplied screws.

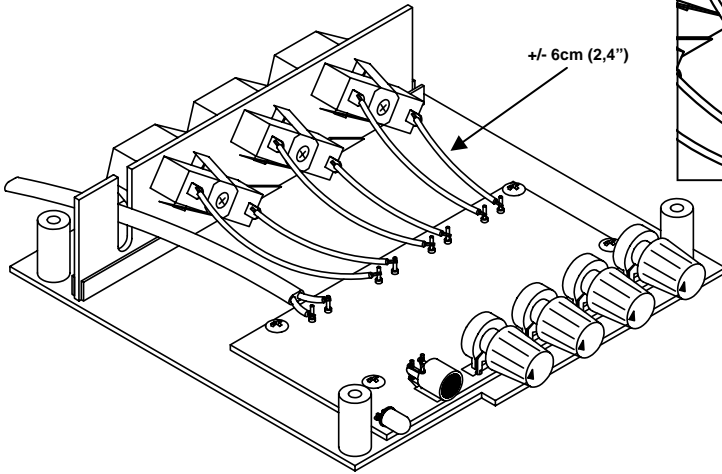
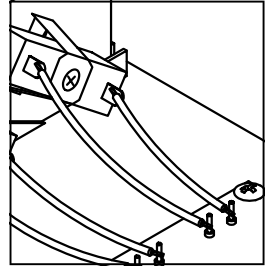

17. Hook-up and use

As this kit is shipped to different countries, there is no AC plug supplied. You will need to attach a plug that matches your electrical system to the loose end of the AC cable. Always close and fasten the enclosure lid before operating this kit. Make sure the AC voltage is correctly set. Fill out the included power rating label and stick it to the bottom of the enclosure. To test the unit, turn all controls fully clockwise and plug it in. When the AC cord is plugged in, the power indicator LED should light. Tap the enclosure gently. The internal LED's will flash. Now you can test the unit with light bulbs connected. Make sure the max. rating per channel is not exceeded ! You can adjust the overall sensitivity by turning the master level control, while the level for each individual channel can be adjusted with the low-, mid- and high level controls.

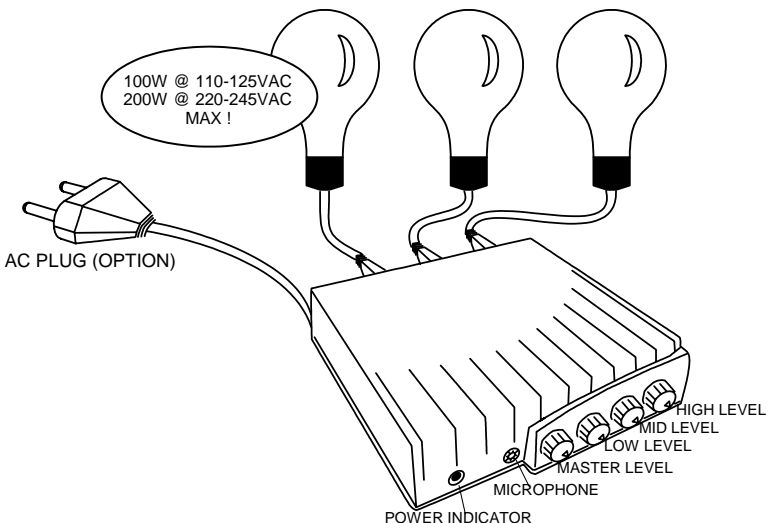

18. Diagram power supply

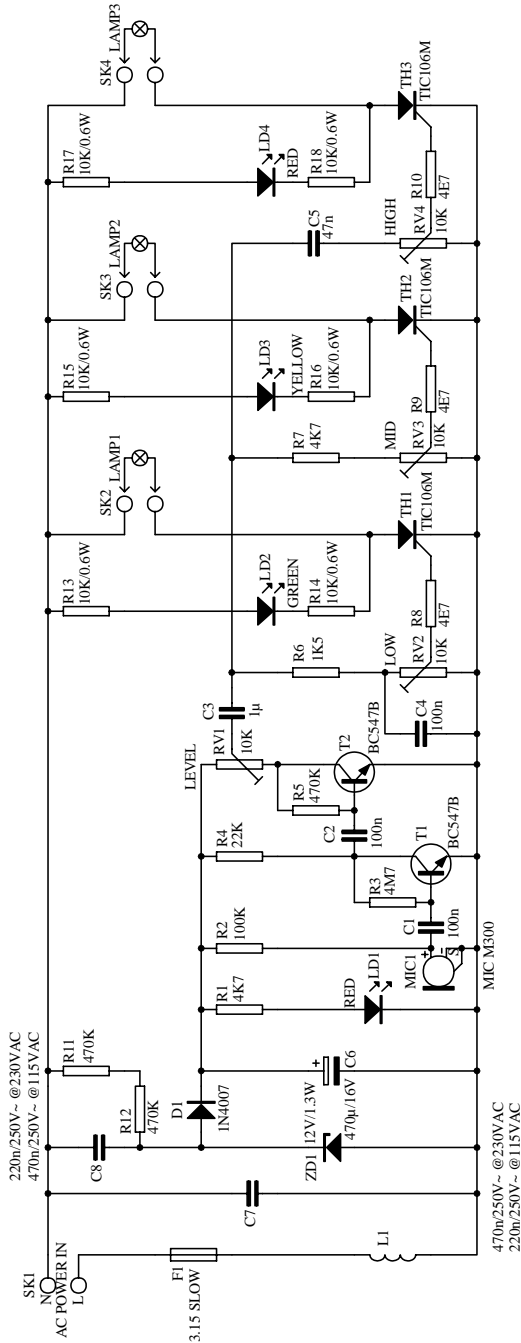

19. PCB

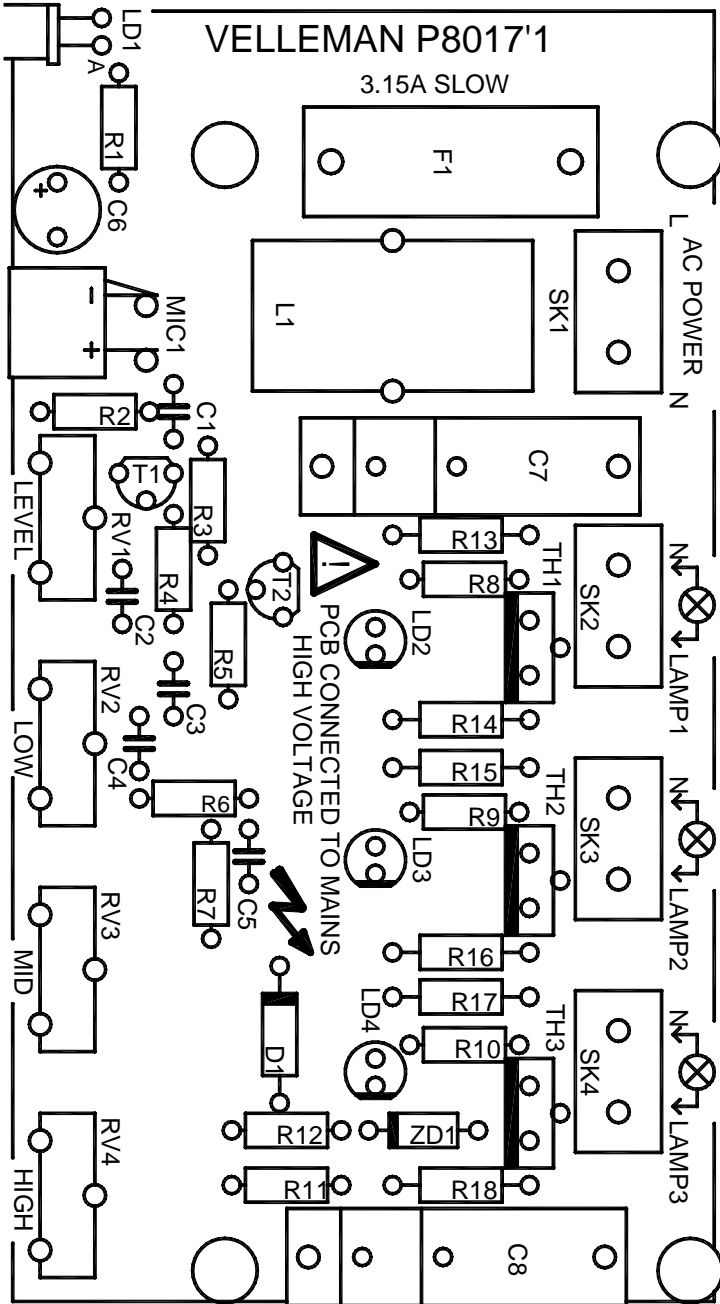



VELLEMAN KIT NV
Legen Heirweg 33
9890 Gavere
Belgium Europe
Info ? : <http://www.velleman.be>

Modifications and typographical errors reserved
© Velleman Kit nv
H8017IP - 2004 - ED1

